

LoadLIFTER7500XL™



Installation Guide

Kit 57538

*Chevrolet/GMC
Heavy Duty*



Representative vehicle image

MN-1034 • (011612) • ERN 8635

For maximum effectiveness and safety, please read these instructions completely before proceeding with installation.

Failure to read these instructions can result in an incorrect installation.

Load**LIFTER**7500**XL**

Table of Contents

Installation Diagrams	2
Hardware List and Tools List	3
Hardware List	3
Tools List	3
Introduction	4
Important Safety Notice	4
Notation Explanation	4
Installing the LoadLifter 7500 XL System	5
Getting Started	5
Air Spring Assembly	6
Positioning the Air Spring Assembly on the Axle	7
Attaching the Upper Brackets	7
Reattaching the Emergency Brake Cable to the Frame	8
Attaching the Lower Brackets	9
Installing the Air Lines	10
Tips for Installing Air Lines	11
Installing the Heat Shield	11
Finished Installation Photos	12
Before Operating	13
Checking for Leaks	13
Fixing Leaks	13
Installation Checklist	14
Post-Installation Checklist	14
Product Use, Maintenance and Servicing	15
Minimum and Maximum Pressure	15
Maintenance Guidelines	15
Tuning the Air Pressure	16
Guidelines for Adding Air	16
Troubleshooting Guide	17
Frequently Asked Questions	17
Limited Warranty and Returns Policy	21
Replacement Part Information	21
Contact Information	21



Installation Diagram

NOTE: If the vehicle has fifth-wheel hitch brackets along the side of the frame, the U-bolts may not be used.

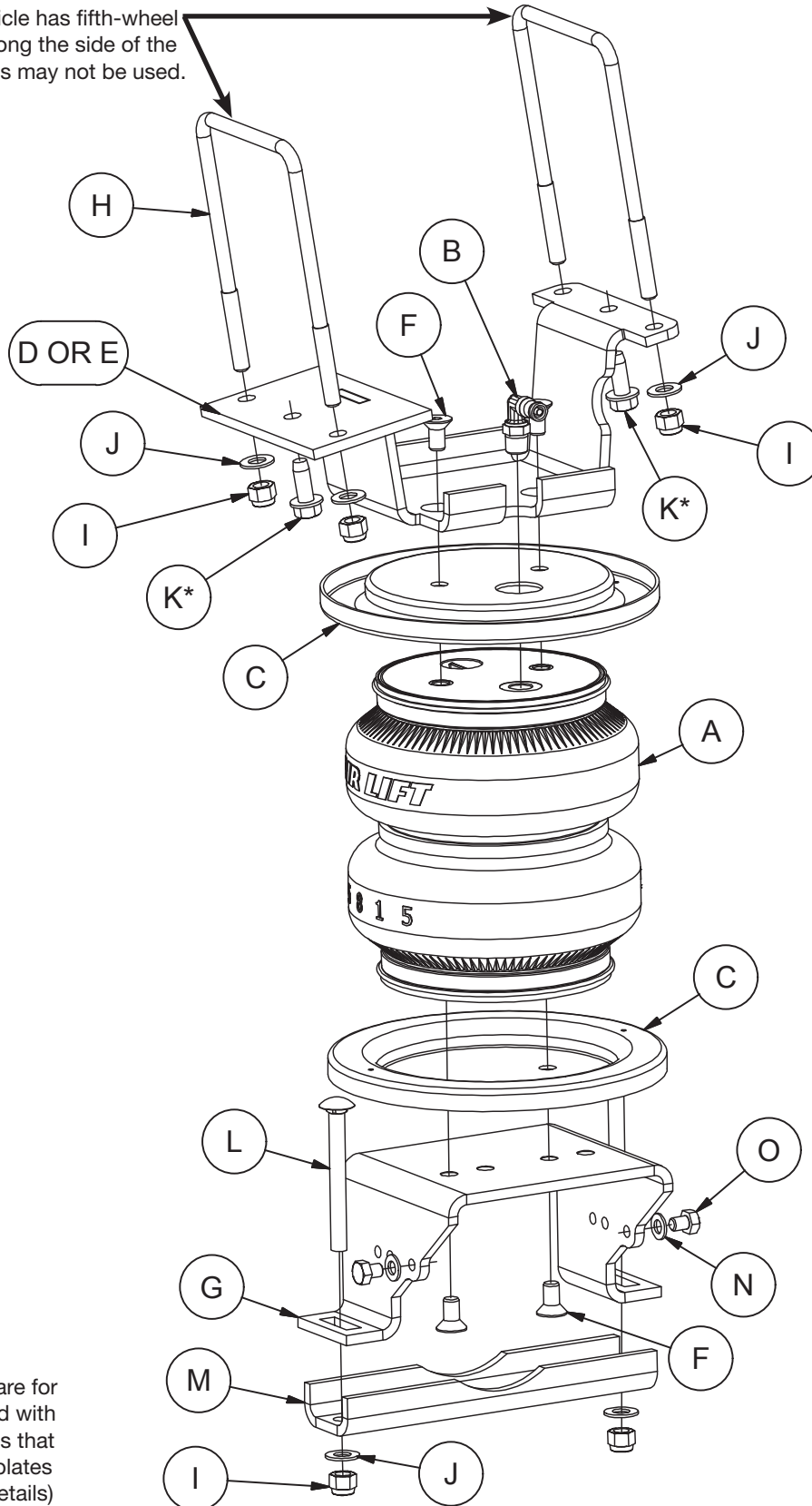

* Optional hardware for vehicles equipped with fifth-wheel hitches that have frame side plates (see page 7 for details)

fig. 1

Hardware and Tools Lists

HARDWARE LIST

Item	Part #	Description	Qty
A	58115	Air spring.....	2
B	21830	90° Swivel fitting	2
C	11897	Roll plate	4
D	07905	Upper bracket, right.....	1
E	07804	Upper bracket, left	1
F	17215	3/8"-24 x .75" Flat head screw	8
G	03702	Lower bracket	2
H	11046	U-bolt	4
I	18435	3/8"-16 Nylon lock nut	12
J	18444	3/8" Flat washer	12
K	17129	3/8" Self-tapping screws	4
L	17142	3/8"-16 x 3.5" Carriage bolts	4
M	01851	Clamp bar	2
N	18501	M8 Flat washer.....	5
O	17449	M8-1.25 x 10 Hex cap screw.....	3
P	18422	3/8"-16 Serrated flange lock nut.....	1
Q	26333	Emergency brake cable bracket	1
R	10466	Zip ties	6
S	21230	Valve cap.....	2
T	21233	5/16" Hex nut.....	4
U	21234	5/16" Rubber washer.....	2
V	18411	Star washer	2
W	20086	Air line assembly	1

TOOLS LIST

Description.....	Qty
Metric & STD open-box end wrenches	set
Ratchet with metric and STD sockets.....	set
Drill and 5/16" drill bit.....	1
Torque wrench.....	1
Hex key wrenches metric and STD	set
Hose cutter, razor blade or sharp knife	1
Hoist or floor jack	1
Safety stands.....	2
Safety glasses	1
Air compressor or compressed air source	1
Spray bottle with dish soap/water solution.....	1



Missing or damaged parts? Call Air Lift customer service at (800) 248-0892 for a replacement part.

Introduction

The purpose of this publication is to assist with the installation, maintenance and troubleshooting of the LoadLifter 7500 XL air spring kit. LoadLifter 7500 XL utilizes sturdy, reinforced, commercial-grade double convolute bellows. The bellows are manufactured like a tire with layers of rubber and cords that control growth. LoadLifter 7500 XL kits are recommended for most 3/4- and 1-ton pickups and SUVs with leaf springs and provide up to 7,500 pounds of load-leveling support with air adjustability from 5-100 PSI.

It is important to read and understand the entire installation guide before beginning installation or performing any maintenance, service or repair. The information here includes a hardware list, tool list, step-by-step installation information, maintenance guidelines and operating tips.

Air Lift Company reserves the right to make changes and improvements to its products and publications at any time. For the latest version of this manual, contact Air Lift Company at **(800) 248-0892** or visit **airliftcompany.com**.

IMPORTANT SAFETY NOTICE

The installation of this kit does not alter the gross vehicle weight rating (GVWR) or payload of the vehicle. Check your vehicle's owner's manual and do not exceed the maximum load listed for your vehicle.

Gross vehicle weight rating: The maximum allowable weight of the fully loaded vehicle (including passengers and cargo). This number — along with other weight limits, as well as tire, rim size and inflation pressure data — is shown on the vehicle's Safety Compliance Certification Label.

Payload: The combined, maximum allowable weight of cargo and passengers that the truck is designed to carry. Payload is GVWR minus the base curb weight.

NOTATION EXPLANATION

Hazard notations appear in various locations in this publication. Information which is highlighted by one of these notations must be observed to help minimize risk of personal injury or possible improper installation which may render the vehicle unsafe. Notes are used to help emphasize areas of procedural importance and provide helpful suggestions. The following definitions explain the use of these notations as they appear throughout this guide.



INDICATES IMMEDIATE HAZARDS WHICH WILL RESULT IN SEVERE PERSONAL INJURY OR DEATH.



INDICATES HAZARDS OR UNSAFE PRACTICES WHICH COULD RESULT IN SEVERE PERSONAL INJURY OR DEATH.



INDICATES HAZARDS OR UNSAFE PRACTICES WHICH COULD RESULT IN DAMAGE TO THE MACHINE OR MINOR PERSONAL INJURY.

NOTE

Indicates a procedure, practice or hint which is important to highlight.

Installing the LoadLifter 7500 XL System

GETTING STARTED

1. Raise the frame and support the frame with jack stands. Lower the axle as far as it can go (Fig. 2).

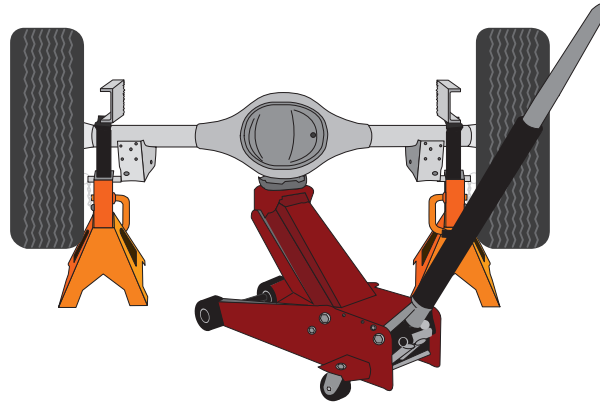
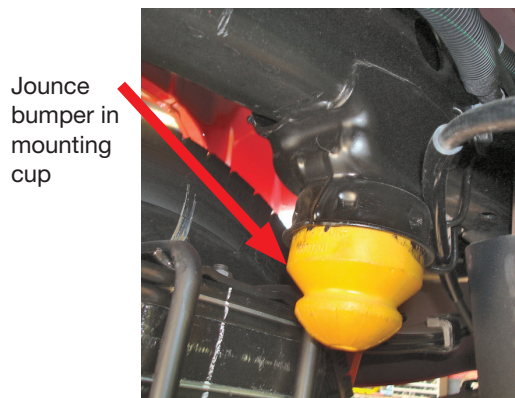

fig. 2

2. Remove the jounce bumper from the jounce bumper bracket on both sides of the vehicle by prying them out with a pry bar or large screwdriver (Figs. 3 & 4).



Jounce bumper in mounting cup

fig. 3

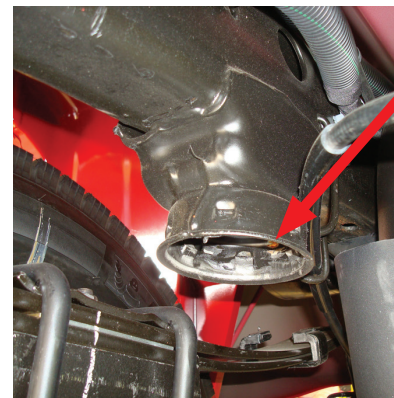

Jounce bumper removed

fig. 4

3. Remove the bolt that holds the emergency brake bracket to the inside of the driver's side frame rail (Figs. 5 & 6).

Remove the bolt and discard the emergency brake bracket

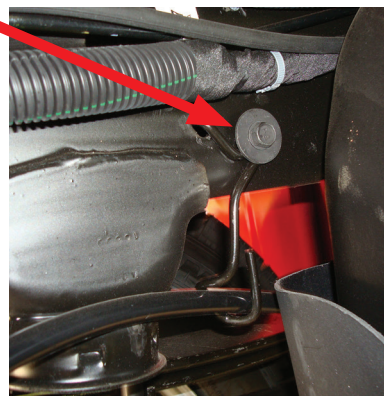

fig. 5



Bolt and emergency brake bracket removed

fig. 6

4. Remove the three bolts that hold the brake lines to the rear axle jounce bumper strike plates (Figs. 7 & 8).
5. Pull the emergency brake cables clear of the jounce bumper strike plate on the axle to make room for the lower bracket (Fig. 8).

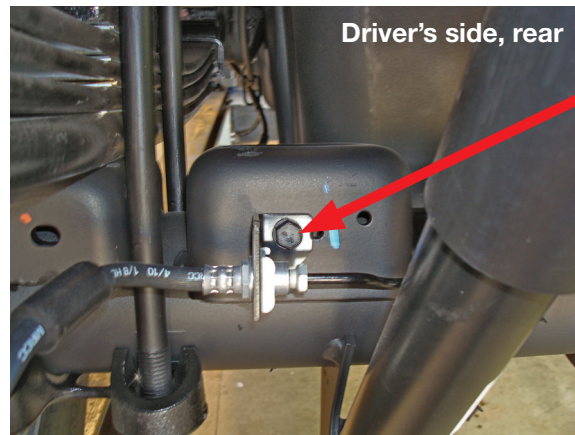

Remove the bolt holding the brake line to the jounce bumper strike plate in the rear on both driver's and passenger's side.

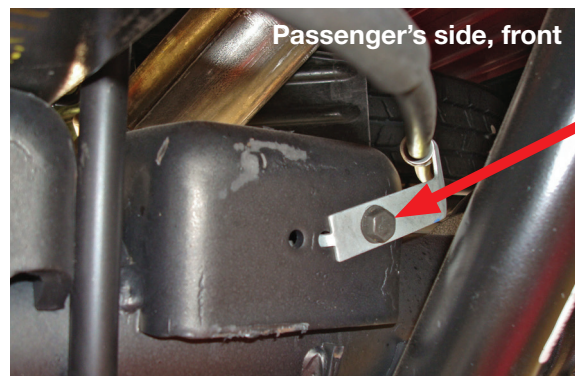
fig. 7

Remove the bolt holding the emergency brake cable on the front of the passenger's side jounce bumper strike plate.

fig. 8

AIR SPRING ASSEMBLY

1. Set a roll plate (C) on both ends of the air spring. The radiused (round) edge of the roll plate will be toward the air spring, enabling the air spring to be seated in both roll plates.
2. Install the 90-degree elbow fitting (B) on top of the air spring. Tighten finger tight plus 1 1/2 turns. Be careful to only tighten on the metal hex nut. Do not overtighten (Fig. 9).

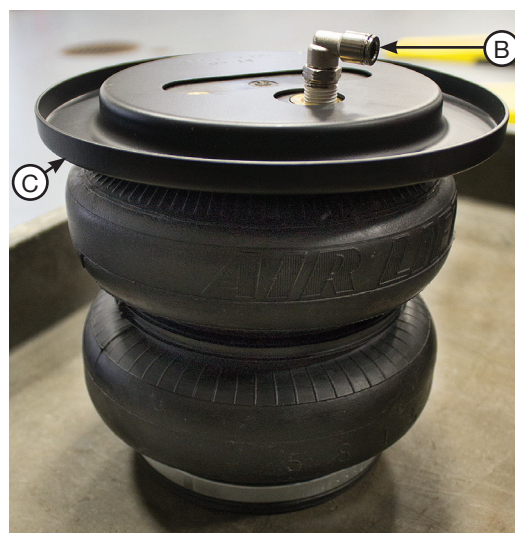

Set roll plate (C) over the air spring and install the fitting (B). Repeat for both air springs.

fig. 9

3. Install the upper brackets (D or E) onto the top of the air springs using the 3/8" flat-head bolts (F) (Fig. 10). Tighten securely.
4. To determine which holes in the lower bracket to use, set them next to each other with the angled sections pointing toward each other. Use the first and third holes on each bracket to attach the air springs. This will make them into left and right assemblies. Attach the lower bracket onto the air spring with two 3/8" flat-head bolts (F) and torque to no more than 20 lb.-ft. (27Nm).

NOTE

The angled side of the lower bracket will be on the fitting side of the air spring (Figs. 1 & 10).

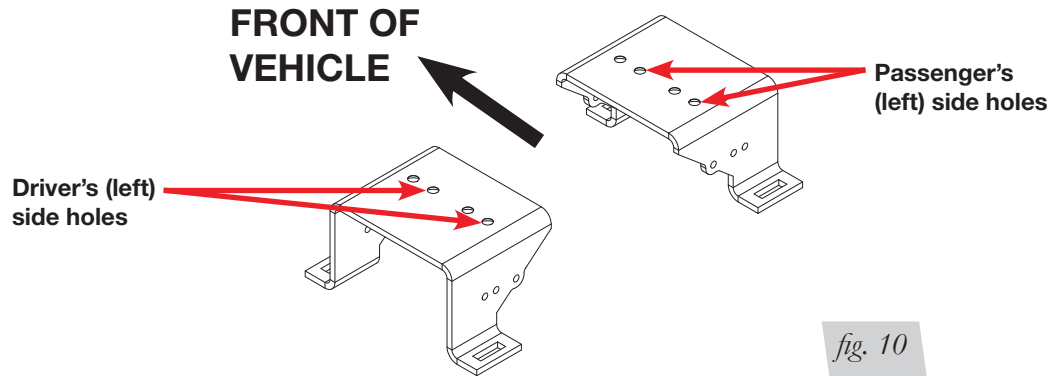
**POSITIONING THE AIR SPRING ASSEMBLY ON THE AXLE**

1. With the suspension hanging, set the left and right hand units over the axle jounce bumper strike plates.

NOTE

The fittings will be on the inside of the frame.

2. Position the upper brackets to nest around the jounce bumper mount attached to the bottom of the frame.

ATTACHING THE UPPER BRACKETS

There are two ways of attaching the upper bracket:

For trucks that do not have a fifth-wheel hitch bracket alongside the frame:

1. Insert two U-bolts (H) onto the top of the frame and through the upper bracket mounting holes (Fig. 11). The U-bolts must be between the frame and the brake lines and wiring.

Insert the U-bolts between the frame and brake line harness as shown. Do not pinch these items between the U-bolt and frame.

**NOTE**

It may be necessary to raise the axle at this point for the upper bracket to reach the frame.

2. Cap with four 3/8" nylon lock nuts (I) and flat washers (J). Torque the U-bolts evenly in a criss-cross pattern to 10 lb.-ft. (14Nm). Repeat for the opposite side.

TECH TIP

Stuff a shop towel between the gas tank and shield to keep the washer and nut from falling in between in case they are dropped during installation.

CAUTION

THE DRIVER'S SIDE HAS A BRAKE LINE AND A WIRING HARNESS RUNNING ALONG THE INSIDE OF THE FRAME. MAKE SURE THE U-BOLT IS BETWEEN THESE ITEMS AND THE FRAME (DO NOT PINCH THESE ITEMS) (FIG. 11).

NOTE

On the passenger's side of some models, it might be necessary to bend the heat shield slightly to gain access for the U-bolt to go over the frame correctly (Fig. 12).

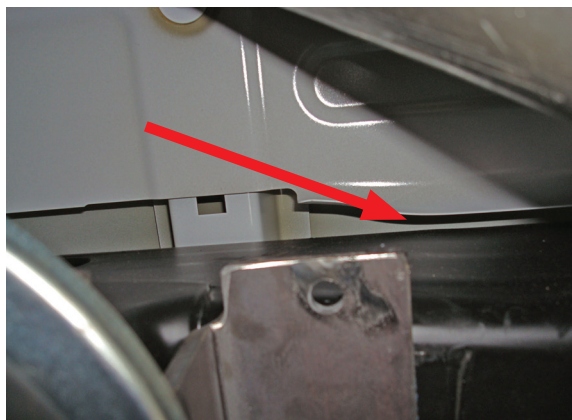

fig. 12

For trucks that have fifth-wheel hitch brackets along side the frame rail:

1. There are holes in the middle of the bracket just forward and behind the jounce bumper mounting cups on the upper bracket. Once the upper brackets are in position, drill two 5/16" holes through the bottom of the frame using the holes as a template and attach the upper brackets using the self tapping screws (K). Torque all four fasteners to 15 lb.-ft. (20Nm).

REATTACHING THE EMERGENCY BRAKE CABLE TO THE FRAME

1. Attach the emergency brake cable removed in the "Getting Started" section with the emergency brake cable bracket (Q) and 3/8" serrated flange lock nut (P) (Fig. 13). Use the inside forward leg of the U-bolt on the driver's side for the attachment. Tighten securely.

NOTE

It may be necessary to pinch the clamp together with pliers to align the two holes up enough to get over the U-bolts.

Emergency
brake cable

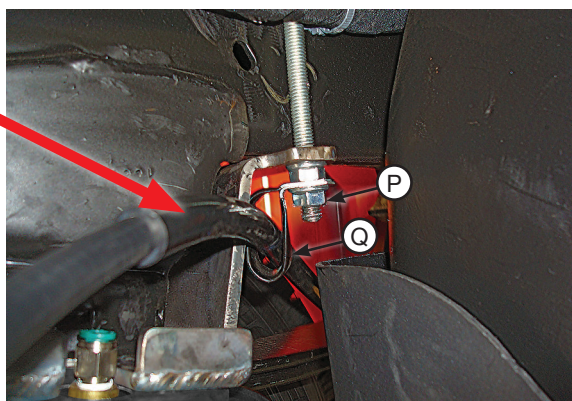

fig. 13

ATTACHING THE LOWER BRACKETS

1. Position the lower bracket to best align the bellows. Insert two 3/8" x 3.5" carriage bolts (L) through lower bracket mounting legs (Fig. 14).

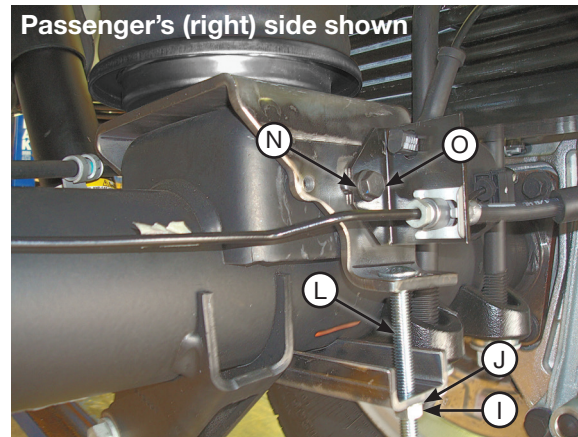

fig. 14

2. Insert the lower clamp bar (M) over the two carriage bolts previously installed and cap with two 3/8" nylon lock nuts (I) and flat washers (J). Torque evenly to 16 lb.-ft. (22Nm).
3. Attach the brake lines that were un-bolted from the rear of the axle in the "Getting Started" section by attaching them to the lower bracket with the new M8 screws (O) and flat washers (N) provided (Fig. 14). Tighten securely.
4. Attach the brake cable on the passenger's side, forward of the axle with the new M8-1.25 x 10 hex cap screw (O) and 3/8" flat washer (J). Tighten securely.

NOTE

It may be necessary to slightly bend this bracket to clear the edge of the lower bracket (Fig. 15).

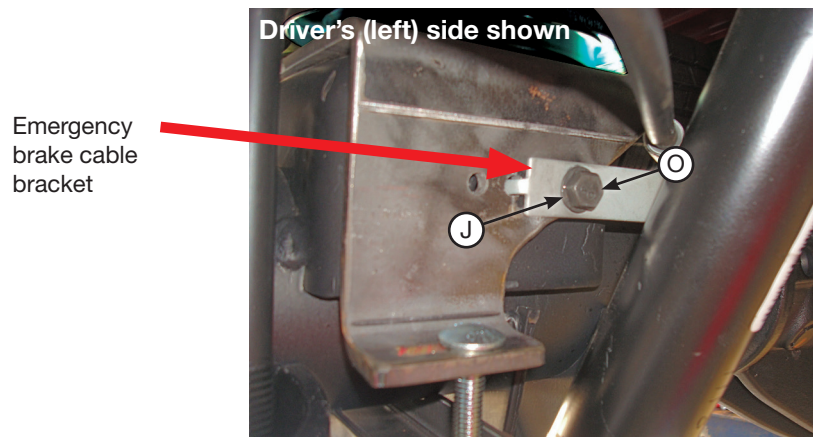

fig. 15

Installing the Air Lines

This section explains how to set up the air spring kit to be controlled with Schrader valves and a separate compressed air source. An on-board air compressor system allows for hassle-free control of the air springs. Learn more about Air Lift control systems at www.airliftcompany.com/products/compressor-systems.

1. Choose a convenient location for mounting the inflation valves (Fig. 16). Popular locations for the inflation valve are:
 - a. The wheel well flanges
 - b. The license plate recess in bumper
 - c. Under the gas cap access door
 - d. Through the license plate

NOTE

Whatever the chosen location, make sure there is enough clearance around the inflation valves for an air chuck.

2. Drill 5/16" holes to install the inflation valves.

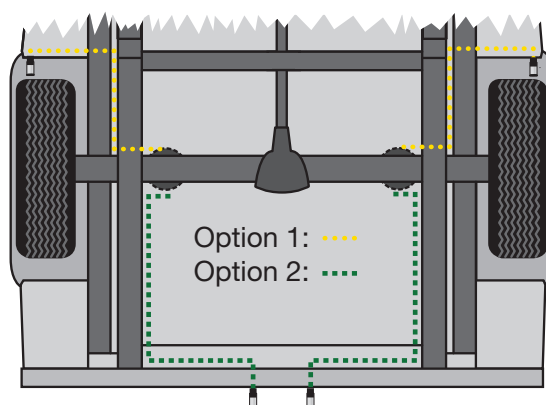

fig. 16

3. Cut the air line assembly in two equal lengths.
4. Place a 5/16" nut and star washer on the air valve. Leave enough of the inflation valve in front of the nut to extend through the hole and have room for the rubber washer, flat washer, and 5/16" nut and cap. There should be enough valve exposed after installation – approximately 1/2" – to easily apply a pressure gauge or an air chuck (Fig. 17).
5. Push the inflation valve through the hole and use the rubber washer, flat washer, and another 5/16" nut to secure it in place. Tighten the nuts to secure the assembly.

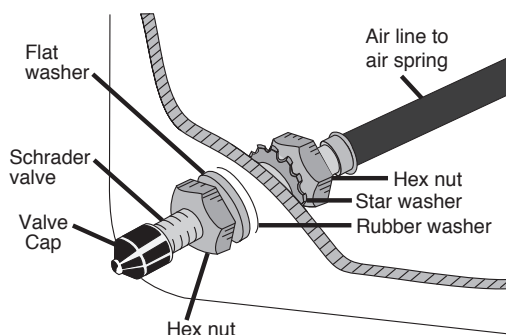

fig. 17

6. Route the air line along the frame to the fitting on the air spring (Fig. 16). Keep AT LEAST 6" of clearance between the air line and the exhaust system. Avoid sharp bends and edges. Use zip ties to secure the air line to fixed points along the chassis. Be sure that the tie straps are tight, but do not pinch the air line. Leave at least 2" of slack to allow for any movement that might pull on the air line.
7. Cut off the air line, leaving approximately 12" of extra air line. A clean square cut will prevent leaks. Insert the air line into the air fitting. This is a push-to-connect fitting.

TECH TIP

Wiggle the hose back and forth while inserting to make sure the hose bottoms out in the fitting to obtain a good seal.

TIPS FOR INSTALLING AIR LINES

When cutting air lines, use a sharp knife or a hose cutter and make clean, square cuts (Fig. 18). Do not use scissors or wire cutters because these tools may deform the air line, causing it to leak around fittings. Do not cut the lines at an angle.

Do not bend the 1/4" hose at a radius of less than 1" or bend the 3/8" hose at a radius of less than 1 1/2". Do not put side load pressure on fitting. The hose should be straight beyond the fitting for 1" before bending.

Inspect hose for scratches that run lengthwise on hose prior to installation. Contact Air Lift customer service at (800) 248-0892 if the air line is damaged.



To watch a video demonstrating proper air line cutting, go to air-lift.co/cuttingairline.

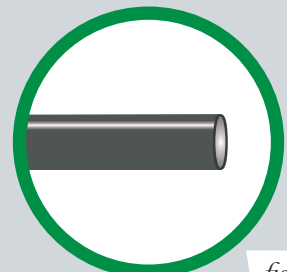

fig. 18

**INSTALLING THE HEAT SHIELD**

1. Bend tabs to provide a dead air space between exhaust pipe and heat shield. (Fig. 19) Attach the heat shield to the exhaust pipe using the clamps. Bend the heat shield for maximum clearance to the air spring.

NOTE

Some vehicles have large resonators in this area; it will be necessary to double up on the clamps to fit these models (Fig. 19).

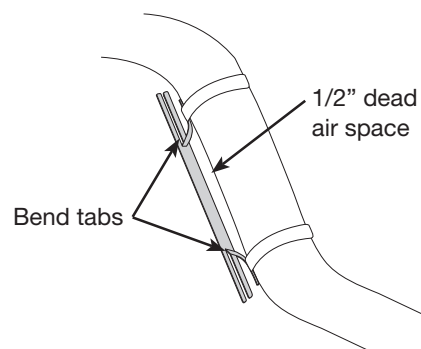

fig. 19

Finished Installation Photos

1. The following images show the finished installation of both sides (Figs. 20, 21, 22 & 23).



Driver's (left) side as viewed from the rear.



Passenger's (right) side as viewed from the middle of the vehicle.



Driver's (left) side as viewed from the middle rear of the vehicle.



Passenger's (right) side as viewed from the rear.

Before Operating

CHECKING FOR LEAKS

1. Inflate the air spring to 30 PSI.
2. Spray all connections and the inflation valves with a solution of 1/5 liquid dish soap and 4/5 water. Spot leaks easily by looking for bubbles in the soapy water.
3. After the test, deflate the springs to the minimum pressure required to restore the system to normal ride height. Do not deflate to lower than 5 PSI.
4. Check the air pressure again after 24 hours. A 2-4 PSI loss after initial installation is normal. Retest for leaks if the loss is more than 5 PSI.

FIXING LEAKS

1. If there is a problem with the swivel fitting:
 - a. Check the air line connection by deflating the spring and removing the line by pulling the collar against the fitting and pulling firmly on the air line. Trim 1" off the end of the air line. Be sure the cut is clean and square (see Fig. 18). Reinsert the air line into the push-to-connect fitting.
 - b. Check the threaded connection by tightening the swivel fitting another half turn. If it still leaks, deflate the air spring, remove the fitting, and re-coat the threads with thread sealant. Reinstall by hand tightening as much as possible and then use a wrench for an additional two turns.
2. If there is a problem with the inflation valve:
 - a. Check the valve core by tightening it with a valve core tool.
 - b. Check the air line by removing the air line from the barbed type fitting. Cut the air line off a few inches in front of the fitting and use a pair of pliers or vice grips to pull/twist the air line off of the fitting.



CAUTION

DO NOT CUT OFF THE AIR LINE COMPLETELY AS THIS WILL USUALLY NICK THE BARB AND RENDER THE FITTING USELESS.

3. If the preceding steps have not resolved the problem, call Air Lift customer service at **(800) 248-0892**.

INSTALLATION CHECKLIST

- Clearance test** — Inflate the air springs to 75-90 PSI and make sure there is at least 1/2" clearance from anything that might rub against each sleeve. Be sure to check the tire, brakes, frame, shock absorbers and brake cables.
- Leak test before road test** — Inflate the air springs to 75-90 PSI and check all connections for leaks. All leaks must be eliminated before the vehicle is road tested.
- Heat test** — Be sure there is sufficient clearance from heat sources, at least 6" for air springs and air lines. If a heat shield was included in the kit, install it. If there is no heat shield, but one is required, call Air Lift customer service at **(800) 248-0892**.
- Fastener test** — Recheck all bolts for proper torque.
- Road test** — The vehicle should be road tested after the preceding tests. Inflate the springs to recommended driving pressures. Drive the vehicle 10 miles and recheck for clearance, loose fasteners and air leaks.
- Operating instructions** — If professionally installed, the installer should review the operating instructions with the owner. Be sure to provide the owner with all of the paperwork that came with the kit.

POST-INSTALLATION CHECKLIST

- Overnight leak down test** — Recheck air pressure after the vehicle has been used for 24 hours. If the pressure has dropped more than 5 PSI, then there is a leak that must be fixed. Either fix the leak yourself or return to the installer for service.
- Air pressure requirements** — It is important to understand the air pressure requirements of the air spring system. Regardless of load, the air pressure should always be adjusted to maintain adequate ride height at all times while driving.
- Thirty-day or 500-mile test** — Recheck the air spring system after 30 days or 500 miles, whichever comes first. If any part shows signs of rubbing or abrasion, the source should be identified and moved, if possible. If it is not possible to relocate the cause of the abrasion, the air spring may need to be remounted. If professionally installed, the installer should be consulted. Check all fasteners for tightness.

Product Use, Maintenance and Servicing

Minimum Recommended Pressure	Maximum Air Pressure
5 PSI	100 PSI

MAINTENANCE GUIDELINES

NOTE

By following the steps below, vehicle owners will obtain the longest life and best results from their air springs.

1. Check air pressure weekly.
2. Always maintain normal ride height. Never inflate beyond 100 PSI.
3. If you develop an air leak in the system, use a soapy water solution (1/5 liquid dish soap and 4/5 water) to check all air line connections and the inflation valve core before deflating and removing the air spring.



CAUTION

FOR SAFETY AND TO PREVENT POSSIBLE DAMAGE TO THE VEHICLE, DO NOT EXCEED MAXIMUM GROSS VEHICLE WEIGHT RATING (GVWR), AS INDICATED BY THE VEHICLE MANUFACTURER. ALTHOUGH THE AIR SPRINGS ARE RATED AT A MAXIMUM INFLATION PRESSURE OF 100 PSI, THE AIR PRESSURE ACTUALLY NEEDED IS DEPENDENT ON LOAD AND GVWR.

4. Loaded vehicles require at least 25 PSI. A “loaded vehicle” refers to a vehicle with a heavy bed load, a trailer or both. Never exceed GVWR, regardless of air spring, air pressure or other load assist. The springs in this kit will support approximately 40 pounds of load (combined on both springs) for each 1 PSI of pressure. The required air pressure will vary depending on the state of the original suspension. Operating the vehicle below the minimum air spring pressure will void the Air Lift warranty.
5. When increasing load, always adjust air pressure to maintain normal ride height. Increase or decrease pressure from the system as necessary to attain normal ride height for optimal ride and handling. Remember that loads carried behind the axle (including tongue loads) require more leveling force (pressure) than those carried directly over the axle.
6. Always add air to springs in small quantities, checking the pressure frequently.
7. Should it become necessary to raise the vehicle by the frame, make sure the system is at minimum pressure (5 PSI) to reduce the tension on the suspension/ brake components. Use of on-board leveling systems do not require deflation or disconnection.
8. Periodically check the air spring system fasteners for tightness. Also, check the air springs for any signs of rubbing. Realign if necessary.
9. On occasion, give the air springs a hard spray with a garden hose to remove mud, sand, gravel or other debris.

TUNING THE AIR PRESSURE

Pressure determination comes down to three things — level vehicle, ride comfort and stability.

1. Level vehicle

If the vehicle's headlights are shining into the trees or the vehicle is leaning to one side, then it is not level (Fig. 24). Raise the air pressure to correct either of these problems and level the vehicle.

2. Ride comfort

If the vehicle has a rough or harsh ride it may be due to either too much pressure or not enough (Fig. 25). Try different pressures to determine the best ride comfort.

3. Stability

Stability translates into safety and should be the priority, meaning the driver may need to sacrifice a perfectly level and comfortable ride. Stability issues include roll control, bounce, dive during braking and sponginess (Fig. 26). Tuning out these problems usually requires an increase in pressure.

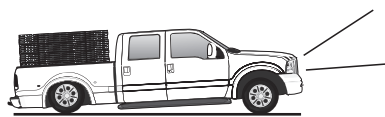

Bad headlight aim

fig. 24



Rough ride

fig. 25

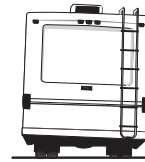

Sway and body roll

fig. 26

GUIDELINES FOR ADDING AIR

1. Start with the vehicle level or slightly above.
2. When in doubt, always add air.
3. If the front of the vehicle dives while braking, increase the pressure in the front air bags, if equipped.
4. If it is ever suspected that the air bags have bottomed out, increase the pressure (Fig. 27).
5. Adjust the pressure up and down to find the best ride.
6. If the vehicle rocks and rolls, adjust the air pressure to reduce movement.
7. It may be necessary to maintain different pressures on each side of the vehicle.
Loads such as water, fuel, and appliances will cause the vehicle to be heavier on one side (Fig. 28). As much as a 50 PSI difference is not uncommon.



Bottoming out

fig. 27

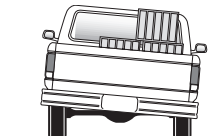

Unlevel

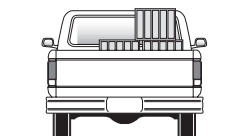

Level

fig. 28

Troubleshooting Guide

PROBLEM	CAUSE	SOLUTION
System won't maintain pressure overnight.	Improperly installed air line, air line has holes or cracks.	Leak test the air line connections, the threaded connection into the air spring, and all fittings in the control system.
Air spring or air line leak.	Fitting seal or air line is compromised.	Check to make sure air lines are seated in connectors. Inspect fittings with soapy water. Trim hose or re-seal fitting. Ensure lines are cut straight.
Corner won't raise or air leak develops.	Look for a kink or fold in the air line.	Replace any air line that has been kinked.

FREQUENTLY ASKED QUESTIONS

Q. Will installing air springs increase the weight ratings of a vehicle?

No. Adding air springs will not change the weight ratings (GAWR, GCWR and/or GVWR) of a vehicle. Exceeding the GVWR is dangerous and voids the Air Lift warranty.

Q. Is it necessary to keep air in the air springs at all times and how much pressure will they need?

For LoadLifter 7500 XL, the recommended minimum air pressure is 5 PSI, but it can safely be run at zero air pressure.

Q. Is it necessary to add a compressor system to the air springs?

No. Air pressure can be adjusted with any type of compressor as long as it can produce sufficient pressure to service the springs. Even a bicycle tire pump can be used, but it's a lot of work.

Q. How long should air springs last?

If the air springs are properly installed and maintained they can last indefinitely.

Q. Will raising the vehicle on a hoist for service work damage the air springs?

No. The vehicle can be lifted on a hoist for short-term service work such as tire rotation or oil changes. However, if the vehicle will be on the hoist for a prolonged period of time, support the axle with jack stands in order to take the tension off of the air springs.

Notes



Notes

Notes

Limited Warranty and Return Policy

Air Lift Company provides a limited lifetime warranty to the original purchaser of its Load Support products, that the products will be free from defects in workmanship and materials when used on cars and trucks as specified by Air Lift Company and under normal operating conditions, subject to the requirements and exclusions set forth in the full Limited Warranty and Return Policy that is available online at www.airliftcompany.com/warranty.

For additional warranty information contact Air Lift Company customer service.

Replacement Part Information

If replacement parts are needed, contact the local dealer or call Air Lift customer service at **(800) 248-0892**. Most parts are immediately available and can be shipped the same day.

Contact Air Lift Company customer service at (800) 248-0892 first if:

- Parts are missing from the kit.
- Need technical assistance on installation or operation.
- Broken or defective parts in the kit.
- Wrong parts in the kit.
- Have a warranty claim or question.

Contact the retailer where the kit was purchased:

- If it is necessary to return or exchange the kit for any reason.
- If there is a problem with shipping if shipped from the retailer.
- If there is a problem with the price.

Contact Information

Mailing address	P.O. Box 80167 Lansing, MI 48908-0167
Shipping address for returns	2727 Snow Road Lansing, MI 48917
Phone	Toll free: (800) 248-0892 International: (517) 322-2144
Email	service@airliftcompany.com
Web address	www.airliftcompany.com

Need Help?

Contact Air Lift Company customer service department by calling (800) 248-0892.

For calls from outside the USA or Canada, dial (517) 322-2144.



Thank you for purchasing Air Lift products — the professional installer's choice!

Air Lift Company • 2727 Snow Road • Lansing, MI 48917 or P.O. Box 80167 • Lansing, MI 48908-0167
Toll Free (800) 248-0892 • Local (517) 322-2144 • Fax (517) 322-0240 • www.airliftcompany.com